

Call Recorder Single II

Manual

V2.3

VC2002



Vidicode
Blauw-roodlaan 140
2718 SK Zoetermeer
The Netherlands

Phone
+31(0)79 3617181
Fax
+31(0)79 3618092

Sales
+31(0)79 3471010
Support
+31(0)79 3471005

Email
vidicode@vidicode.nl
Internet
www.vidicode.nl

vidicode

The Call Recorder Single II

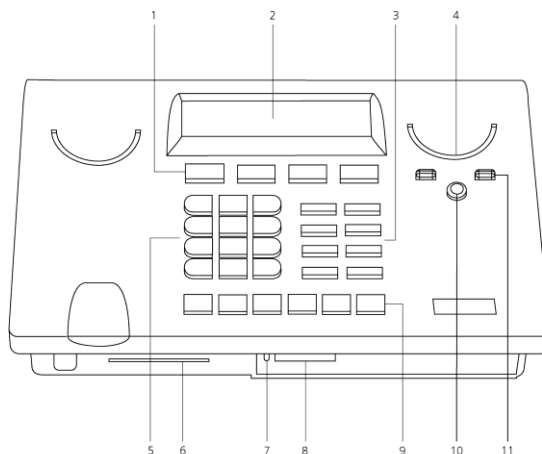

1. Menu-keys
2. Backlight Display
3. Function keys
4. Speaker
5. Alfa-Numerical keys
6. CryptoCard reader
7. SD inserted LED (red)
8. SD card Slot
9. Recorder keys
10. Speakerphone key
11. Volume adjustment

Connection

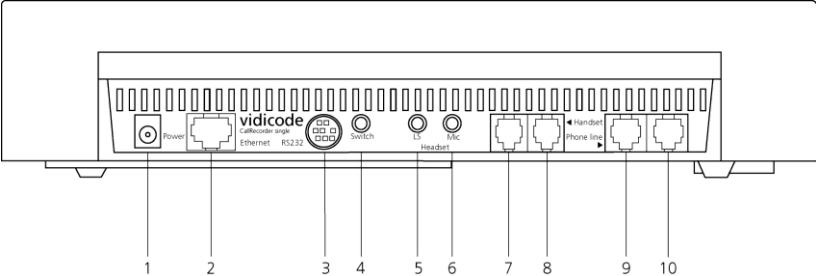



1. Power
2. Ethernet/LAN
3. RS 232 Serial
4. Switch
5. Loudspeaker
6. Microphone
7. Handset
8. Handset
9. Phone line Out
10. Phone line In

Recorder-keys

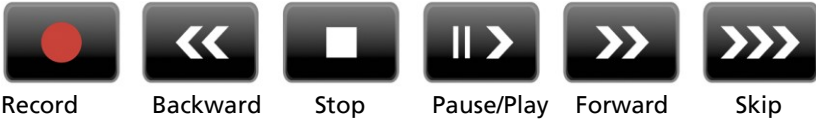
The recorder keys have specific functions in different situations although the operation is always very similar. During recording and playback the keys have the standard recorder key functions as explained below.







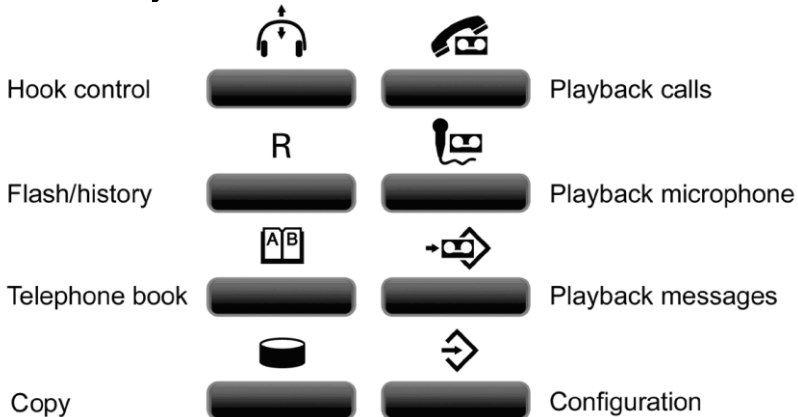







The  and  keys can be used to scroll through numbers in the telephone book or through a settings menu. If no recording or playback is taking place these keys always have an Up/Down or Left/Right function. The  key will always exit the current operation.

Function-keys



Alfa-numerical functions

Numerical keys	Function				
	Press the relevant key repeatedly or hold down:				
	1x	2x	3x	4x	5x
	1	.	:	'	;
	A	B	C	2	!
	D	E	F	3	%
	G	H	I	4	^
	J	K	L	5	\$
	M	N	O	6	@
	P	Q	R	5	7
	T	U	V	8	&
	W	X	Y	Z	9
	*	@	/	<	>
	#	<	>	[]
Recorder keys	Function				
	Toggle uppercase and lowercase				
	Forward				
	Backward				

Care and Maintenance





	<p>Keep the Single II dry. If it gets wet, wipe it dry immediately. Liquids might contain minerals that can corrode the electronic circuits.</p>
	<p>Use and store the Single II only in normal temperature environments. Temperature extremes can shorten the life of electronic devices and distort or melt plastic parts.</p>
	<p>Keep the Single II away from excessive dust and dirt that can cause premature wear of parts.</p>
	<p>Do not use harsh chemicals, cleaning solvents or strong detergents to clean the Single II.</p>

Table of contents

1	Operation and Important information	11
1.1	Frequently used key indicators.....	11
1.2	Save Changes	12
1.3	Adjust the Volume	12
2	Getting started	13
2.1	Out of the box.....	13
2.2	Connecting the power supply	14
2.3	Setting up the Single II for use	14
2.3.1	Set the clock.....	14
2.3.2	Select the language.....	15
3	About the Call Recorder.....	17
3.1	Automatic recording.....	19
3.2	Notification	19
3.3	Compression.....	20
3.4	Microphone mode	20
3.5	Automatic Gain Control.....	20
4	Connecting to the recording source.....	21
4.1	Record from an analogue telephone line	21
4.1.1	Configure Record from Line	22
4.2	Record from a digital telephone	23
4.2.1	Configure Record from Handset.....	23
4.2.2	Voice activated recording	24
4.2.3	Set Start level, stop level and Silence Timeout	24
4.3	Recording from the microphone	25
5	Search and play recordings	26
5.1	Search recordings.....	27
5.2	Search according to date	27
5.3	Search according to code.....	28
6	Copy recordings to SD card.....	29
6.1	Copy the last recording to SD card.....	29
6.2	Copy a selection of recordings	29
6.3	Copy an individual recording during playback	30

7	Single II as Telephone.....	31
7.1	Headset / Speakerphone.....	31
7.2	Handset	32
7.3	Starting a call	32
7.4	Accept a call	33
7.5	End a call	33
8	Single II as Answering machine	34
8.1	Turn the answering machine On / Off.....	34
8.2	Record a message.....	35
8.3	New Messages.....	36
8.4	Playback messages	36
8.5	Remove messages	37
8.6	System messages	38
9	The Telephone book	41
9.1	Add a contact.....	41
9.2	Search a contact.....	42
9.3	Making a call from the telephone book	42
9.4	Edit a contact	42
9.5	Remove a contact.....	43
9.6	Call History	43
10	Using the CryptoCard	44
10.1	Insert CryptoCard into Single II.....	44
10.2	The CryptoCard and its PIN and PUC code	44
10.3	Making an encrypted recording	45
10.4	Playing an encrypted recording.....	45
11	The Network Interface	47
11.1	The Possibilities	47
11.2	Network configuration	47
12	Settings	48
12.1	Recording Source	49
12.2	Start method	49
12.3	Telephone settings.....	50
12.3.1	External handset.....	50

12.3.2	Flash time	51
12.3.3	Wait after dial	51
12.3.4	Caller ID	51
12.3.5	K-break detection	52
12.3.6	Rings to answer on	52
12.3.7	Rings always answer	52
12.3.8	Ring Volume	53
12.3.9	Ring frequency	53
12.3.10	Ring variation	53
12.3.11	Speaker after answer	54
12.3.12	Maximum message time	54
12.4	Recorder Settings	55
12.4.1	CryptoCard	55
12.4.2	Automatic SD Copy	56
12.4.3	Notification	56
12.4.4	Ask Store/Delete	57
12.4.5	Beep after store	57
12.4.6	Minimum call time	58
12.4.7	Signal settings	58
12.4.8	Start Period	60
12.4.9	Silence period	60
12.4.10	Compression	60
12.4.11	Microphone mode	61
12.4.12	Microphone amplification	61
12.4.13	Automatic Gain Control	61
12.4.14	Footswitch	61
12.5	Network settings	63
12.5.1	Network active	63
12.5.2	FTP active	63
12.5.3	FTP user	63
12.5.4	FTP password	64
12.5.5	FTP server port	65
12.5.6	DHCP server	65
12.5.7	IP address	66
12.5.8	IP subnet mask	66
12.5.9	Gateway	67
12.5.10	IP name	67
12.5.11	NTP server	68
12.5.12	NTP port	68
12.5.13	GMT correction	69
12.5.14	Monitor Active	69
12.6	Clock	70
12.7	Password	71

12.8	Language.....	72
12.9	Reset all Values	72
	Acknowledgements.....	73
12.10	Guarantee.....	73
12.11	Liability	73
13	Index.....	74

1 Operation and Important information

The Call Recorder Single II comes in different versions; the HD9900 with or without activated SD-interface and the Flash 10 with or without activated SD-interface.

In this manual it is assumed that the Single II has an activated SD-interface. The menu options and possibilities of the recorder may be different to what you see in this manual if you have a Single II without SD-interface option.

The Single II has a common menu driven user interface. Most functions and operations are initiated by pressing a function key followed by a sequence of display determined menu keys. The use of function keys and menu keys is indicated as follows:

Function keys

The most frequently used functions of the Single II have been grouped in the function keys. Pressing one of the function keys will always result in a display where the various options are assigned to the four menu keys.

Menu keys

After pressing a function key the available options are assigned to the four menu keys. The operation of the menu keys is determined by the text in the display right above the corresponding key. If there is an underlying menu the **MENU** key will open this menu.

Example with the keys:

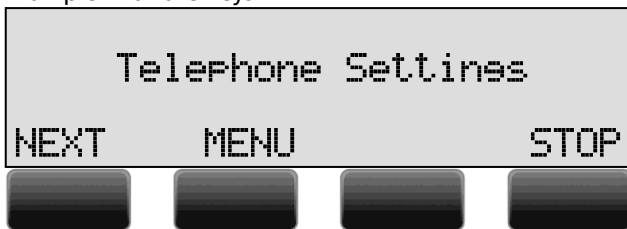

In this example you can open the Telephone settings menu by pressing the corresponding MENU key.

1.1 Frequently used key indicators

The following menu key functions are consistently used throughout the manual.

MENU in the display indicates the presence of an underlying menu

- Press **MENU** to open the underlying menu

NEXT in the display indicates the presence of more menu items

- Press **NEXT** to jump to the next menu item

BACK in the display indicates the presence of an embracing menu

- Press **BACK** to return to the embracing menu

STOP in the display indicates the absence of an embracing menu

- Press **STOP** to return to operating mode

CHANGE will toggle the item in the display between "On" and "Off"

The different models Single II use a Drive or Flash Disk with an optional SD card as additional storage medium. In the operations and settings menus the available options will be displayed as **DISK** or **SD**.

1.2 Save Changes

After altering the settings the alterations have to be confirmed. After pressing **STOP** the display as shown below will appear.

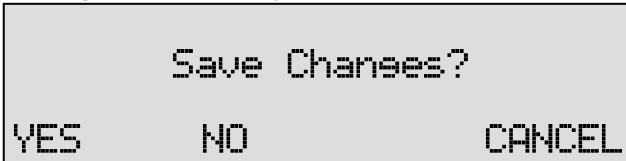

YES returns the Single II to normal use with changed settings

NO returns the Single II to normal use without changed settings

CANCEL returns to the settings

1.3 Adjust the Volume

The speaker volume of the Single II can be adjusted easily.

Use the + and - keys below the speaker to adjust the volume. The volume can be set separately for speakerphone and handset use.



2 Getting started

In this Chapter the connections of the Single II are described. There are different types of the Single II:

Single II Flash 10 (max. 10 hours recording capacity on Flash disk)

Single II HD 9900 (max. 10.880 hours recording capacity on Drive.)

2.1 Out of the box

In the box of the Single II you will find:

- Call Recorder Single II
- Power adapter
- Flat telephone cable
- Curled telephone cable
- Quick guide
- CD containing manual

Options with the Call Recorder Single II:

- SD activation card + SD card & SD access system license
- Call Recorder SD Access software
- Araña web interface
- Handset
- Headset
- Microphone

2.2 Connecting the power supply

The Single II is powered through a wall socket power adapter.

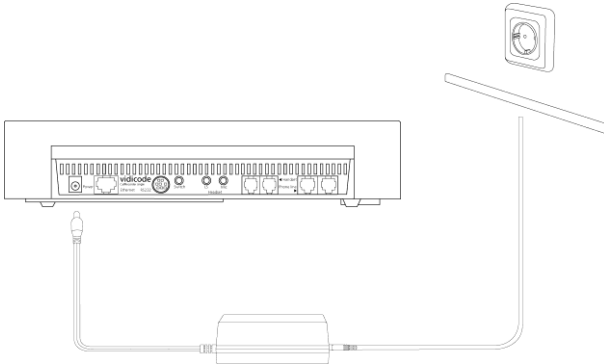

- First connect the power adapter to the wall socket.
- Then connect the mini jack of the adapter to the Power connector on the back side of the Single II.

2.3 Setting up the Single II for use

To configure the Single II for use the Clock needs to be set and the Language needs to be selected. Setting the Clock and selecting the Language are described in the next two paragraphs.

2.3.1 Set the clock

Set the clock as follows:

- Press  **Configuration** function key and press **NEXT** five times.

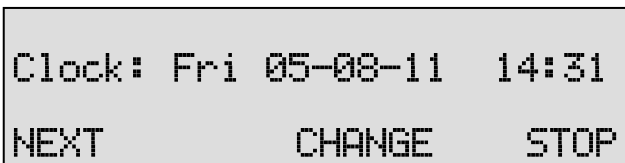

- Press **CHANGE** to set the clock

```
Clock: Fri 05-08-11 14:31
STORE  <<  >>  CANCEL
```

- Press keys 1 - 7 to set the day:

1 = Sunday
2 = Monday
3 = Tuesday
4 = Wednesday
5 = Thursday
6 = Friday
7 = Saturday

```
Clock: Tue 05-08-11 14:31
STORE  <<  >>  CANCEL
```

- Enter the date (format depends on selected language)

```
Clock: Tue 02-08-11 14:31
STORE  <<  >>  CANCEL
```

- Enter the time
- Press **STORE** to save the time.

Other options:

- **CANCEL** to return to previous set time.
- << and >> to move the cursor.
- Press **NEXT** twice to continue with language selection.

2.3.2 Select the language

Select the language as follows:

- Press  **Configuration** function key and press **NEXT** seven times

```
Language:      English
NEXT          CHANGE  STOP
```

- Press **CHANGE** to scroll through the available languages.
- Press **STOP** to return to the main display.

Together with the Language the date format can change also:

Standard date format is: DD-MM-YY

When set to "American" the format is changed to : MM-DD-YY

Setting the Call Recorder up for recording is described in the next chapter.

3 About the Call Recorder

The Single II is designed for continuous unattended recording. Recordings can be started and stopped automatically for each individual call. The method of automatic starting and stopping of recordings can differ for the various configurations. Please check the Chapter 12 about the Settings for details.

There are different versions of the Single II. The use and operation for the different models is exactly the same. In the Search/Playback menu you will be prompted to select "Disk" or "SD" before the menu continues.

The Call Recorder Single II comes in different versions; the HD9900 and the Flash 10.

In this manual it is assumed that the Single II has an activated SD-interface. The menu options and possibilities of the recorder may be different to what you see in this manual if you have a Single II without activated SD-interface.

Drive or Flash

Depending on the model the Single II has an internal Drive or Flash Disk. All recordings are stored digitally on one of the available data carriers. The storage capacity of the Drive ensures the Call Recorder's ability of long term unattended recording. Other advantages of the Call Recorder are that recordings are randomly searchable. If the SD card option is purchased from Vidicode, the SD Access software will give quick and easy access to the database of recordings on the SD card.

The Single II issues a warning when the Drive is getting full. If the warning is ignored the oldest recordings will be overwritten by the newest. Stored recordings can be archived using the optional Call Recorder Access software. It is also possible to copy recordings from the Drive to SD. Copying recordings to SD can be done in different ways for different purposes. It is possible to copy one recording, copy a selection of recordings or copy all new recordings automatically. Recordings on SD can be viewed and played with the SD Access software that comes with the SD card option.

Compression

The digital format of the recordings is determined by the use of speech compression. The Call Recorder compresses recordings default according to the GSM format. This type of compression has a good balance between audio quality and recording size and is compatible for most Windows versions. Compressed recordings take up 1/5th of the size of uncompressed recordings. Therefore the compression has a profound effect on the storage capacity of the Call Recorder in terms of recording time.

Network Interface

All Singles have a Network interface. The Single II can be connected to a PC or computer network through the Ethernet interface. With its own IP address the Call Recorder acts as an Ftp-server from which recordings can be downloaded. The optional Call Recorder Access software can be used to connect to the Call Recorder over the network to retrieve recordings from the Single II and archive the recordings on the PC. The Call Recorder Access software has extensive archiving capabilities including the creation of special archives suited for backup on CD. The Ethernet connection also allows for RTR Call monitoring over the network. The optional RTR Call Monitor software can be used to monitor all connected telephone lines over the network.

Search and playback

The Single II has its own menu driven search function to find and play specific recordings. Recordings can be searched for according to Date and Code, by default the Called number or Caller ID will be stored as Code. The Single II has an internal speaker for playback of recordings.

Security

All recordings can be encrypted. The Single II uses the CryptoCard option for this feature. Playback of encrypted recordings is impossible without the CryptoCard. Playback of encrypted recordings on a PC is possible only with the optional CryptoCard reader in conjunction with the original or a matching CryptoCard.

3.1 Automatic recording

Automatic recording is determined by the Start Method in the configuration, see § 12.2 for a description. When the recording Start Method is set to "Manual" recordings can be started manually using the recorder keys.

NOTE: There is one setting with which Automatic recording is not possible: When the use of the announcement message has been enabled the recording of outgoing calls need to be started manually.

For incoming calls the recording announcement message is played when the phone is picked up.

For outgoing calls it is not possible to determine what the correct moment is to play the message. Therefore the recording can only be started manually and the message is played directly after the recording is started.

The display will show **START** when the announcement message has been selected in the menu.

3.2 Notification

In certain countries or regions the recording of the telephone call has to be announced to the remote caller. There are two ways to let the remote caller know the call is being recorded

Notification tone. The notification tone is a regularly returning beep. The beep can be heard both by the local and the remote caller. The Single II features a smart notification tone where the beep is sounded only when a silence occurs during the call. This way you can always be sure the remote caller will hear the beep.

Notification message: The notification message is a spoken message that can notify the callers the call is being recorded. The message has to be recorded first.

The notification message is given on a different moment for incoming and outgoing calls.

For incoming calls the message is given when the phone is being picked up. For outgoing calls the moment of playing the message is determined manually. The reason is that the Single II cannot determine when the remote side picks up the phone. Even when Automatic recording is enabled the recording of outgoing calls has to be started manually when the notification message is enabled. The recording is started by

pressing **START** in the display. The notification message is played when the recording is started.

The notification tone and message can be enabled separately and simultaneously. See § 12.4.3 for details.

3.3 Compression

The recording quality refers to the format of the file that the recording is stored in. The file format is determined by the way the recording is compressed. The compression in turn determines the file size and the quality of the recording. A high compression rate generally has a poorer quality.

The Single II supports 2 different formats. The table below shows the relation between recording quality and storage capacity.

Recording quality	Flash 10	SD 2GB	SSD 64GB	Bytes/Sec.
G.711 A-law	2 hrs	69 hrs	2208 hrs	8000
GSM	10hrs	340 hrs	10880 hrs	1625

By default the Single II is set to record in GSM compression format.

3.4 Microphone mode

When using an External Microphone it should be connected to the microphone connection that is associated with the option to connect a headset.

The microphone mode is set in § 12.4.11.

3.5 Automatic Gain Control

Automatic Gain Control adjusts the recording level of the local and remote voice to attain similar audio levels during playback of the recording. The Automatic Gain Control is enabled by default to ensure the recording quality for the local and remote voice. Automatic Gain Control is set in § 12.4.13.

4 Connecting to the recording source

The Single II can record from analogue phones, from digital phones or from a microphone.

When recording from an **analogue** phone line the Call Recorder is connected to the phone line (either series or in parallel) and can start and stop recording automatically or manually.

When recording from an analogue phone follow instructions in § 4.1.

When recording from a digital phone the Call Recorder is connected to the handset of the phone. As "Off Hook" and "On Hook" cannot be detected, automatic recording is realised by Voice Activation, or using a switch. Voice activated recording requires the setting of the Start and Stop levels and the Silence period.

When recording from a digital phone follow instructions in § 4.2.

The Single II can also record from a **microphone**. The Single II can record from the internal microphone or record from an external microphone connected to the microphone connection at the back of the device. See § 4.3 for details.

4.1 Record from an analogue telephone line

Connect the Single II between your telephone line wall socket and your telephone.

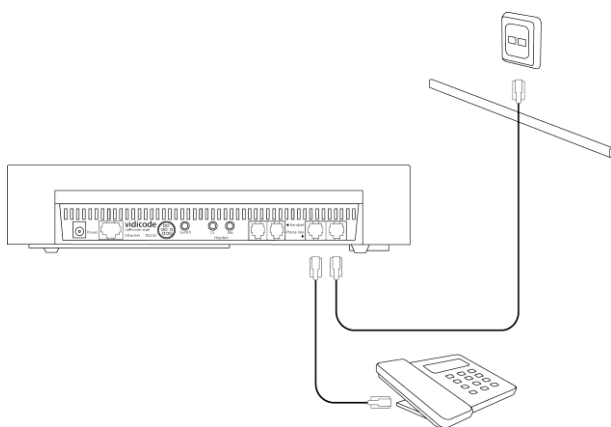

Use the existing telephone line of the telephone to connect the Single II to the telephone line wall socket. The telephone line is connected to the Phone Line In port.

Use the supplied flat cable with two RJ11 connectors to connect the telephone to the Call recorder. Connect the cable to the Phone **Line Out** port on the Single II.

4.1.1 Configure Record from Line

- Press the  **Configuration** function key to enter the settings.

```
Record from:      Line
NEXT              CHANGE  STOP
```

- Press **CHANGE** to select "Line".
- Press **NEXT** to move to the Start method setting:

```
Start:           Series off-hook
NEXT              CHANGE  STOP
```

- Press **CHANGE** to select "Series Off Hook".

Other Start Method options are:

- Parallel Off Hook
- Series + Parallel
- Voice Activated
- Close Contact
- Manually

These options can be used in deviant configurations.

- Press **STOP** to quit the settings menu or continue with the settings in § 12.3.

4.2 Record from a digital telephone

Connect the Single II between your telephone and the telephone handset.

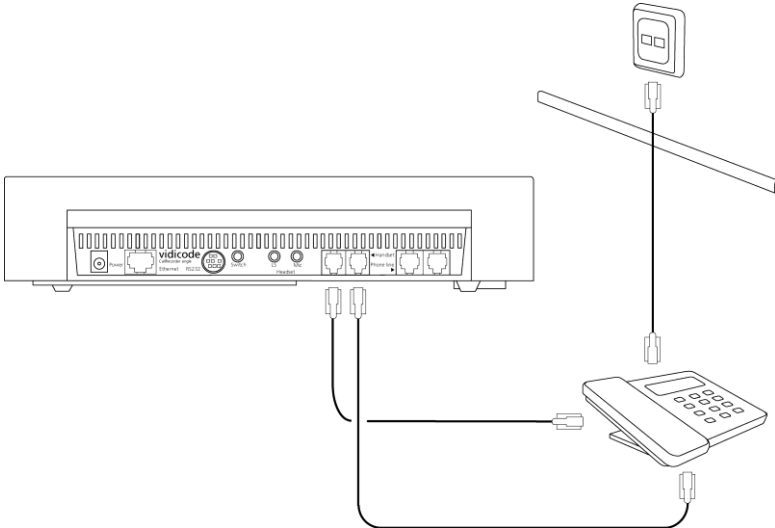

Use your existing telephone handset cable from your telephone to connect the Single II to the telephone.
Use the supplied curled cable with two RJ10 connectors to connect your telephone handset to the Call recorder Single II.

4.2.1 Configure Record from Handset

Press the  **Configuration** function key to enter the settings.



- Press **CHANGE** to select "Handset".
- Press **NEXT** to move to the "Start method" menu item .

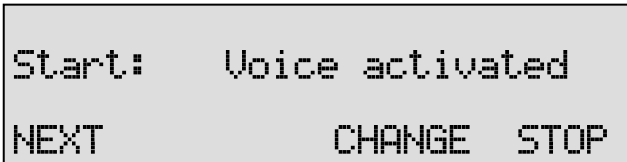

- Press **CHANGE** to select "Voice activated".

Other Start Method options are:

- Close Contact
- Manually (for manual recording)

Some digital phone systems have a contact switch which breaks or makes contact when the phone is taken Off Hook. The making or breaking contact is used by the Call Recorder to Start or Stop a recording. **Close Contact** can be selected if the digital phone system is equipped with a Contact connecting.

4.2.2 Voice activated recording

The principle behind voice activated recording is quite simple. When the Single II detects a "certain" amount of audio signal on the handset it will assume a call is taking place. The "certain" amount is a level that can be set in the Signal settings (§ 12.4.7). This level is called the Start-level.

4.2.3 Set Start level, stop level and Silence Timeout

The **Start**-level determines the level above which the Single II will assume a call is taking place and start recording. More or less the same principle applies to the stopping of the recording.

When the Single II detects that the audio level falls below the set **Stop level** (§ 12.4.7) the Single II will assume the call has ended

The **Silence timeout** is a period of time in seconds that prevents a premature stop when the audio level drops below the Stop level. The recording will be stopped only if the audio level remains below the Stop level for the time of the set Silence timeout.

Now when a silence occurs in a call the recording continues for at least the Silence timeout. If during the recording in the Silence timeout period the audio level exceeds the Stop level again the recording will continue. When a call has ended the audio level will drop below the Stop level and the recording will be stopped after the Silence timeout has passed.



The setup of Voice Activated Recording is all about finding the correct level for the Start and Stop levels and a comfortable time for the Silence timeout. These settings can vary substantially between different situations and are subject to personal preferences.

Voice activated recording can also be used for making microphone recordings, for instance during the recording of meetings.

4.3 Recording from the microphone

The Single II has two different microphone options to record from. An internal microphone that is used for the Speakerphone function, the other is the microphone port to which an external microphone can be connected. See § 12.4.11 through § 12.4.13 for details about the settings.

A quick microphone recording can be started when the telephone is idle.

- Press the **Rec.**  key and the **Play/Pause**  key at the same time.

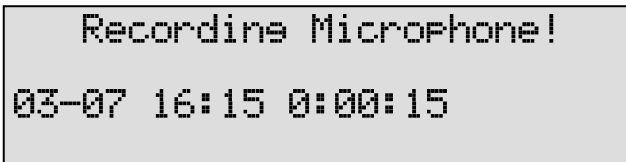

The display will indicate that a microphone recording is taking place.

- Press the **Stop**  key to stop the recording.



- Enter a Code to store with the recording
- Press **STORE** to store the recording

For regular or automatic recording from a microphone the recording source can be set to Microphone. For Start method the same options are available as for "Handset" recording source. See § 4.2.1 for details.

5 Search and play recordings

The Single II has three different kinds of recordings. They are:

- Call recordings,
- Microphone recordings,
- Answering machine messages.

Search and playback of these recordings is initiated with the corresponding function keys. Each recording type has its own Search and playback function key.

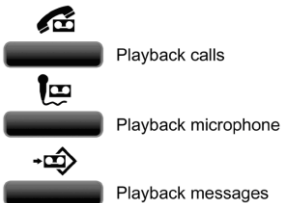

The search and playback menus and operation for the different recordings are virtually the same.



Recordings can be searched for according to Date and Code. For all recordings the date of the recording is stored with the recording. The Code of a recording can be addressed when storing the recording. By default the dialled number or the caller ID is used as Code of a recording.

When a search is started one has to choose between searching the SD card or the Disk. Searching the SD or the Disk is done in exactly the same way.

During the search the * character can be used as a wildcard. The wildcard is default used for the Code search string. This way the search is performed on Date and time only. In the next paragraphs the searching for the various recordings is described.

5.1 Search recordings

In this example it is assumed that you have a Single II with SD option.

- Press one of the Playback function keys  (Calls),  (Microphone),  (Messages).

Then choose from the following options:

- Press **DISK** to search the Drive / Flash disk for the desired recordings
- Press **SD-CARD** to search the SD-card for the desired recordings
- Press **LAST** to play the last recorded call. (If available)

When **SD** or **DISK** is chosen the search continues as below.

5.2 Search according to date

Following from the previous paragraph

```
      Calls from 1-07-14
SEARCH  CODE                STOP
```

- Enter the date of the call you want to search for.
- Press **SEARCH** to execute the entered query.

```
31-07-14  09:48           1/23
SEARCH  CODE                STOP
```

In this example 23 recordings were found. Now the recorder keys can be used to select and play the recordings.

Other options are:

SEARCH to start a new search

CODE to expand the search to the code of the recording. The code search is described below.

STOP to quit searching.

5.3 Search according to code

In the previous paragraph the search according to date has been described. The search can be expanded to incorporate the code of the recording. Throughout the search the code can be incorporated as follows:

- Press **CODE** when you are in the search menu.

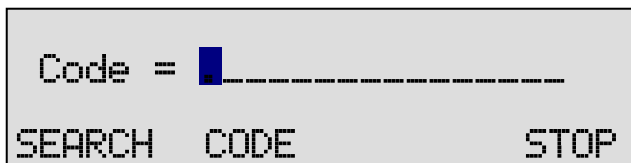

```
Code = █ _____
SEARCH CODE STOP
```

- Enter the desired code you want to search for.
- Press **SEARCH** to search for the entered code.

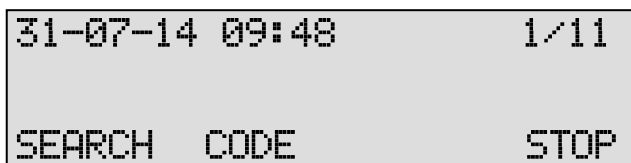

```
31-07-14 09:48 1/11
SEARCH CODE STOP
```

Now the recorder keys can be used to select and play the found recordings.

Example: The date search string "****-03-14**" will return all the calls from March 2014. The date search string "****-*-14**" will return all the calls from the year 2014.

The code search string "***234**" will return all the calls that contain the number 234.

6 Copy recordings to SD card

 This paragraph is only applicable if your Single II has an activated SD interface.

It is possible to copy recordings from the internal disk or Flash memory to SD card. There are different ways to copy recordings to SD card. A copying action is always preceded by a Search action. It is possible to copy a recording while playing it back, or a selection of recordings can be made first, either per day, per month or per week.

6.1 Copy the last recording to SD card

- Press one of the Playback function keys

 (Calls),  (Microphone),  (Messages).

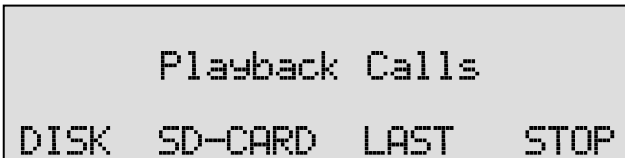

- Press **LAST** to start the playback
- Press copy  function key:

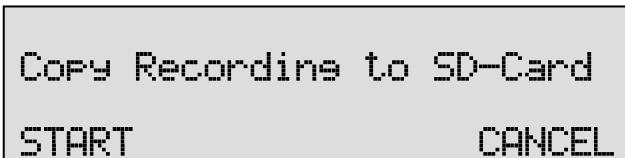

- Press **START** to start copying the last recording.
- Press **CANCEL** to cancel the copy.

6.2 Copy a selection of recordings

- Press one of the Playback function keys

 (Calls),  (Microphone),  (Messages).

```
Playback Calls
DISK  SD-CARD  LAST  STOP
```



- Select **DISK**
- Use the numerical keys to enter a date.

Entering the date or code to search for you can use the * key as wildcard. For example enter **:11:09 to search for all recordings from November 2009. The ◀ and ▶ keys can be used to move the cursor left or right.

```
31-07-11 09:48          1/11
SEARCH  CODE  DELETE  STOP
```

- Press the  function key to open the Copy mode and copy all 11 Recordings to SD.
- Press **SEARCH** to start copying the recordings.
- Press **CANCEL** to cancel the copy.

6.3 Copy an individual recording during playback

First select the recording you want to copy as described in chapter § 5.1. Press  to start the playback then press the  function key.

```
Copy Recording to SD-card
START                          CANCEL
```

- Press **START** to start copying the recording.

7 Single II as Telephone

The Single II is a Call Recorder aimed at the automatic recording of telephone conversations. The Single II can be connected to any regular analogue telephone line and to the handset of a digital telephone. It is meant to automatically record telephone calls. Telephone calls are recorded on Flash disk or Drive during the call. After the calls have ended the recordings can be copied to SD.

The Single II can also be used as telephone. With either a handset, a headset or as speakerphone. In Settings the Single II must be configured to Record from Line. (See §12.1)

NOTE: To use The Single II as Telephone it must be connected to the Line and not the Handset.

The Single II has a standard headset interface to which a headset can be connected.

Recordings can be encrypted using the CryptoCard option. Encrypted recordings can only be played using the same or a matching card to the card the recording was made with. The use of the telephone can be disabled if there is no CryptoCard inserted.

7.1 Headset / Speakerphone

A headset can be connected to the Single II. When the headset is used the Hook control function key can be used for On and Off hook.

The Single II features a hook-control function key  and speakerphone. Both the hook-control and the speakerphone key control Hook contact.

NOTE: The hook-control function key takes precedence over the speakerphone. If the hook-control function is 'Off hook', press the

Speakerphone key  to transfer the call to the speakerphone. The display will show "Speakerphone ON". Press the speakerphone key again to transfer the call back to the hook-control function key. The display will show "Speakerphone OFF". If the call is on speakerphone and the handset is off the hook then pressing the hook-control function key will end the call.

7.2 Handset

An external handset can be purchased as an option. With the handset connected, and the Single II configured with Telephone mode: **ON**, External handset: **ON** (See also § 12.3) The Single can be used as a regular telephone.

7.3 Starting a call

There are three ways to start a call.

- Pick up the handset,
 - Press the Hook control function key,
 - Open the phone book and select a telephone number, and then push the hook-control or lift the handset.
- Push the hook-control function key  and wait for the dial tone.



- Enter the number and wait for the remote phone to ring.

It is also possible to use the Single II entering the number first, before the handset is picked up or the Hook-control pushed. :

- First enter the number.

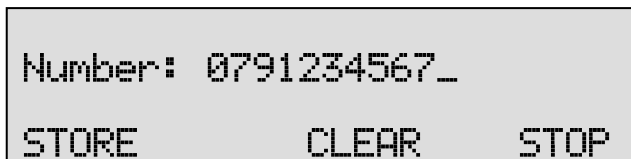

- Then push the hook-control function key 

(If you were to press STORE, the phonebook will open and the number can be stored together with the Name.)



Dial: 0791234567

The number is dialled

Instead of pushing the hook-control function key  .
It is also possible to start a call from the Telephone book. See § 9.3

7.4 Accept a call

When the phone is ringing

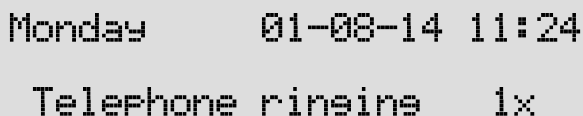

Monday 01-08-14 11:24
Telephone ringing 1x

The Single II will keep track of the number of rings that have passed and shows it in the display.

- Push the hook-control function key  to accept the call, or pick up the handset.

The speakerphone key can also be used to accept the call.

7.5 End a call

A call is ended by putting the handset back on the Single II, pushing the hook-control function key  or by pressing the speakerphone key when the speakerphone was used.

8 Single II as Answering machine

The Single II has a simple answering machine function with the possibility for 30 different welcome messages.

NOTE: Answering machine can only be used when the Single II is connected to the Line. When recording from handset the answering machine function can not be enabled.

Settings include:

- Number of rings to answer on. This is the number of rings before the Single II answers the phone
- Number of rings to always answer. This is the number of rings before the Single II answers the phone when the Answering Machine was turned Off. Hereafter the answering machine stays turned on.
- Enable speaker after answer. This function turns the speaker on when the Single II answers an incoming call. The playing of the welcome message and the caller leaving a message can now be heard through the speaker.
- Maximum message time. This function restricts the duration of the messages.

When new messages have been left on the machine the display will indicate so. When messages have been listened to the Single II will prompt you whether or not to save the messages. For playback of the stored messages see § 8.4.

8.1 Turn the answering machine On / Off

When the Single II is idle the answering machine can be turned on without entering the settings menu.



- Press the far right menu key.



- Press **ON** to turn the answering machine On.

To disable the answering machine follow the instructions as above and press **OFF** to turn the answering machine Off.

8.2 Record a message

The Welcome message is the message the Single II answers an incoming call with when the answering machine is turned on.

- Press the Playback / Search message key 





- Press **WELCOME** to enter the Welcome message menu.

In the Single 30 different messages can be recorded to be set as default welcome message.

- Enter the Code of the welcome message that you want to record using the numerical keys. Press 0-9 for welcome messages 0-9. Press *0-*9 for welcome messages 10-19. Press #0-#9 for welcome messages 20-29. For the example we will record welcome message 15 (*5).



- Press  to start the recording of the welcome message.
- Press  to stop the recording.
- Press  to listen to the recording before saving. It is possible to record the message again as described above.



- Press **STORE** to save the recorded welcome message.

Keep a list of Welcome messages. If you want to change the message to another previously recorded message, simply change the number.

- Press 0-9 for welcome messages 0-9. Press *0-*9 for welcome messages 10-19. Press #0-#9 for welcome messages 20-29.
- Press **STOP**

8.3 New Messages.

When there are new messages on the Single II the display will say:



- Press the **Playback messages** function key  to start listening to the new messages. Playback of the new messages will start immediately.

All the new messages have to be listened to before they can be saved.

During playback messages can be skipped with the skip  key. When all the new messages have been played or scrolled through you will be prompted whether to save or delete the messages.

8.4 Playback messages

- Press Playback messages  function key to start searching for messages.



- Press **DISK** or **SD-CARD** depending on where the messages you are looking for are located.

```

Messages from: 01-07-14
SEARCH      CODE      STOP
  
```

Enter the date of the messages or use * as a wildcard to leave date month or year open.

- Press **SEARCH** to execute the entered query.

or

- Press **CODE** to search according to code.

```

Code = 0-----
SEARCH      DATE      STOP
  
```

- Press **SEARCH** to execute the entered query.

```

01-07-14  11:54      1/23
SEARCH      CODE      STOP
  
```

Now the recorder keys can be used to select and play the messages.

8.5 Remove messages

Perform a search for messages on Disk as described in § 5.1.

```

01-07-14  11:54      1/23
SEARCH      CODE      ERASE  STOP
  
```

Then use the recorder keys to select the message that has to be removed.

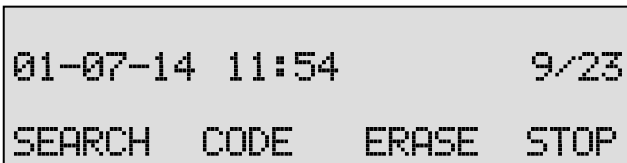

- Press **ERASE** to remove the message.

When all messages that do not need to be saved are removed the rest of the messages can be saved and / or copied to SD. See § 6 for a detailed description.

8.6 System messages

System messages are voice files, stored in the Call Recorder. They are only used in the Answering Machine function. Most of them are used for remote control by the user (listen to new messages remotely etc.). Default, the system messages are stored in the Call Recorder and differ per country. They can be changed using a headset. Not all the below mentioned messages are actually stored.

- To select a system message, press Answering-Machine then **WELCOME** and then **SYSTEM**.

The application will then ask for the system message number. After that, the recorder-keys can be used to record or playback.

Inside the Call Recorder the system messages are stored with the following file names:

MESS<num>.<qua> : <num> = 0-999 , <qua> = 1-7 =
quality/compression

The following numbers are used:

0-9	Zero" till "Nine
188	January
189	February
190	March
191	April
192	May
193	June
194	July
195	August
196	September
197	October
198	November
199	December

200	Hour (optional)
210 - 259	Ten till fifty-nine
300	Default Welcome message
301	Factory Welcome message
302	Factory notification message
303	The message has been stored. Goodbye
304	There are no new messages
309	[temporary storage, do not use]
310	MENU 1 = Listen to new messages 2 = Listen to recordings (hidden, see 333) 3 = Select Welcome message 5 = Change password 6 = Re-record welcome message 9 = Exit
311	Enter password
312	Password is...
313	To Store, press 1, to enter again, press 2, to cancel, press 3
314	Password stored
315	To re-record the welcome message, press 1, to playback current, press 2, to cancel, press 3
316	To re-record again, press 1, to playback, press 2, to cancel press 3, to store press 4
317	Message stored
318	Waiting for your selection (optional after selection time out)
320	Enter Welcome message number
321	This Welcome message does not exist
322	You have select Welcome message.....
323	To store this selection, press 1, to playback this message, press 2, to cancel, press 3
324	Selection stored
330	End of messages
331	Press any key to continue with the next message (Germany only)
333	Enter a 6 digit date [If this message exists (not standard) then searching for and listening to messages remotely is enabled. In that case the Menu in 310 has a new selection, 2.]

335	To listen, press 1, to quit, press 3
339	Goodbye (optional)
340	This call will be recorded [Used for the notification message]
351 - 359	Welcome messages 1 – 9
360 – 369	Welcome messages 10 – 19
370 – 379	Welcome messages 20 - 29

9 The Telephone book

The Single II has an extensive History and Telephone book function. If Caller ID is configured on your telephone line the Single II will automatically display the incoming number when the telephone is ringing.

Both the numbers of incoming and outgoing calls are stored on Disk. By default the Single II also stores the numbers as the **Code** of the recordings.

9.1 Add a contact

- Type in the number that you want to add to the telephone book

```
Number: 059876543█  
STORE    <<    CLEAR  STOP
```

- Press **STORE** to add the number to the telephone book.

```
Name: _  
  
STOP
```

- Enter the Name belonging to the number. Using the alpha numerical keys. Press once for A, twice for B etc.

```
Name: John Brown  
STORE    <<    CLEAR  STOP
```

- Press **STORE** to store the number

```
John Brown  
0598765433  
YES      Store?      NO
```

- Press **YES** to store the entry in the Telephone book.

9.2 Search a contact

- Press the Telephone book  function key

```
Telephone Book
(Press A-Z)

SEARCH                               STOP
```

- Press the numerical key closest to the name you want to search for.

```
John Brown
0598765433

NEXT   EDIT   DELETE   STOP
```

- Press **NEXT** or use the  and  keys to scroll through the list to locate the name you are searching for.

9.3 Making a call from the telephone book

- Press the Telephone book function key.

```
Telephone Book
(Press A-Z)

SEARCH                               STOP
```

Search the contact in the list as described above. To dial the number, pick up the handset or press the Hook-function key and the number will be dialled automatically when the dial tone has been detected.

9.4 Edit a contact

Go through the steps above to locate the entry in the telephone book you want to edit.

```
John Brown
0598765433

NEXT   EDIT   DELETE   STOP
```

- Press **EDIT** to edit the entry.

An identical display is shown as when adding a number to the telephone book.

9.5 Remove a contact

Go through the steps above to locate the entry in the telephone book you want to remove.

```
John Brown
0598765433
NEXT   EDIT   DELETE   STOP
```

- Press **DELETE** to remove the entry from the telephone book.

9.6 Call History

Numbers can also be added to the telephone book through the Call history function. When the telephone is On hook the Flash key (R) has a call history function. Call history keeps track of remote numbers of all your calls. The numbers for outgoing calls are always known. The numbers for incoming calls can only be detected if Caller ID is enabled.

- Press function key **R** to enter the call history.

```
History #1 -> 11-07 09:18
0612345678
STORE                CLEAR   STOP
```

The first call in the history table is the last call made.

The arrow indicates an outgoing call.
Date and time was 11-07 at 09:18 hours.

The **<<** and **>>** keys can be used to scroll through the call history.

- Press **STORE** to move the number to the Telephone book.

Follow the instructions as described in § 9.1.

10 Using the CryptoCard

Encrypting recordings is done to prevent unauthorized playback of and listening to recordings. The Single II uses a CryptoCard to encrypt recordings. The CryptoCard is a chip card that holds the key to the encryption and decryption. Encrypted recordings can only be played back together with the original or a matching CryptoCard. Crypto Cards are available through your supplier.

The Single II is equipped with a card reader specifically for this purpose; it is located on the front side of the device. The use of the CryptoCard is enabled by default inserting a CryptoCard.

10.1 Insert CryptoCard into Single II

Insert the CryptoCard into the Single II as shown in the figure.

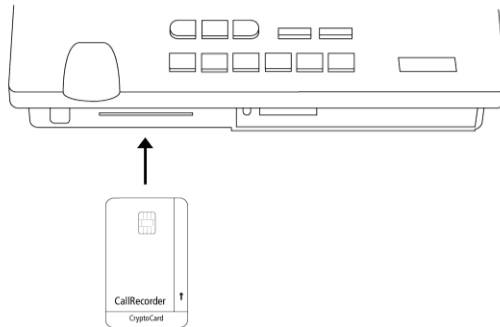

10.2 The CryptoCard and its PIN and PUC code

The CryptoCard is supplied with a PIN code and a PUC code. The PIN code is a four-digit code and is requested by the Single II to enable playback of recordings. The PUC code is a twelve-digit code and is used only when the card has been disabled. The PIN code can be changed on the Single II. See § 12.4.1.

A CryptoCard allows for two invalid PIN code entries. After the third invalid Pin code entry the CryptoCard is disabled. The next time the

Single II will ask for the PUC code to enable the card again. The CryptoCard allows for four invalid PUC code entries. After the fifth invalid PUC code entry the Single II will disable the card definitively. It is advised to keep the PUC code in a safe place.

10.3 Making an encrypted recording

To make encrypted recordings it is essential that the Use CryptoCard function is enabled in the Recorder Settings menu. Enable the Use CryptoCard function as described in § 12.4.1. With Use CryptoCard enabled it is no longer possible to make normal, unencrypted recordings without disabling the Use CryptoCard function again.

- Insert the CryptoCard in the card reader of the Single II.

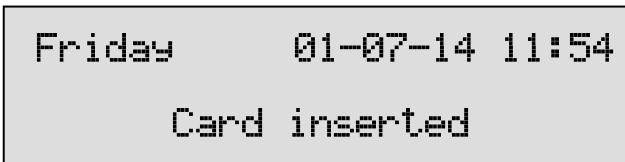

When a valid CryptoCard has been inserted all recordings made thereafter will be encrypted as long as the card remains inserted.

NOTE: Removing the card disables recording automatically.

Encrypted recordings are stored as such and can be played only with a matching CryptoCard inserted. Encrypted recordings can also be played with a PC with the Single II software; however, they cannot be played on the PC without a CryptoCard matching the card used when the recording was made. See the following section for a detailed explanation.

10.4 Playing an encrypted recording

Encrypted recordings can only be played back with the original or a matching CryptoCard. For playback of an encrypted recording on the Single II this works quite simply. Search and select the desired recording as described in Chapter 5. If playback of the encrypted recording is started the Single II will automatically ask for the Card code.

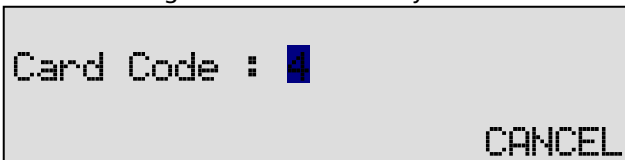

After entering your PIN code the menu key function **CONTINUE** is added in the display.

- Press **CONTINUE** to start playback of the selected recording.

It is not necessary to enter your card code every time.

Your supplier of the Single II can supply you with a Card reader for your PC together with the necessary drivers. The Call Recorder Access software (which can be purchased as an option) will show whether recordings are encrypted or not in the "Use of CryptoCard" column. When an encrypted recording is played the Call Recorder Access software will prompt you for the insertion of a matching card and the belonging code. After that the recording will play. The Call Recorder Access software has the ability to remove the encryption. Encrypted recordings can be exchanged with other PC's just as any other recording. Encrypted recordings can be played on any PC with Call Recorder Access software on it and with the original or matching CryptoCard.

11 The Network Interface

Every Call Recorder has been provided with a 10/100BaseT Ethernet interface.

The protocol chosen for communication via the Network is TCP/IP, the Internet protocol that can be used on most local area networks.

11.1 The Possibilities

The main reason for developing the network interface is to offer the possibility to centrally archive the recordings, or to make a back-up copy of the recordings. The optionally available Call Recorder Access software can be used for archiving a maximum of 250 recorders.

The advantage of the network interface is that they can be retrieved both via the internal network and via the Internet. There are other possibilities, however, and these are listed below:

Archiving by own applications with the help of FTP. The recorder works as a normal FTP server.

Audio monitor function; recordings can be listened to remotely via the loudspeakers of a PC

Remote configuration by system managers

There are various ways in which the connection can be made, so that it is almost always possible to archive or listen remotely. The various possibilities are discussed below.

Connecting one PC with one recorder is possible by supplying the PC with a network card and connecting the PC via a special (crossed) cable. An even simpler way is to use a USB to Ethernet adapter, available as a cable.

Connecting a PC with various recorders in the same building is possible by connecting all recorders and the PC onto the local network. In a large scale application, PC's and recorders are connected via the Internet.

11.2 Network configuration

Configuring the network function of a Call Recorder for local use is not especially difficult, although within a company environment it is advisable for the network manager to enable the network function of the recorder. He or she is the person best suited to judge how the recorder should be configured to function properly with the other systems on the network.

The Network configuration parameters are described in § 12.5.

12 Settings

The Call Recorder Single II comes in different versions; the HD9900 with or without SD-interface and the Flash 10 with or without SD-interface. In this manual it is assumed that the Single II has an SD-interface. The menu options and possibilities of the recorder may be different to what you see in this manual if you have a Single II without SD-interface.



All the settings start with the Configuration function key  followed by the menu keys of which the function is determined by the text in the display as described in Chapter 1. The settings appear in various formats, the display may show:

- a question that can be answered with **YES** or **NO**.
- a function that can be turned **ON** or **OFF**.
- a setting of numerical values.
- a setting of predefined options.

The kind of setting unfolds in the description in the menu and from the display text.

The settings appear in a sequence of questions. The settings are described in exactly that same sequence:

- Recording Source
- Start Method
- Telephone settings (underlying menu)
- Recorder Settings (underlying menu)
- Network settings (underlying menu)
- Clock
- Password
- Language
- Reset all Values

If you require to change one specific setting you can scroll through the settings pressing **NEXT** consecutively or by using the  and  keys to scroll forwards and backwards through the menu.

Press the  **Configuration** function key to enter the settings menu's.

12.1 Recording Source

The Record source is described in Chapter 4.

```
Record from :          Line
NEXT          CHANGE  STOP
```

- Press **CHANGE** to select the desired Record source:

Select:

- Line (analogue telephone)
- Handset (digital telephone)
- Microphone
- Press NEXT to move on to the next menu item.

12.2 Start method

Start method is largely dependant on the way your call recorder is connected to the telephone

```
Start :          Series Off hook
NEXT          CHANGE  STOP
```

Use **Series Off-hook** if you want to start and stop recording automatically and you have an analogue line connected to the Line-in and the telephone on the Line-out of the Single II.

Use **Parallel Off-hook** if you want to automatically start and stop recording and your telephone line is connected on the Line-in using a splitter on the line.

Use **Series + parallel** if you are not sure whether the Single is connected in series or parallel.

Use **Close contact** if the Switch is connected to an external contact, as is used in some types of telephones / PBX's.

Use **Voice activated** if the Single II is connected to the handset of the (digital) telephone.

Use **Manual** if you want to control which call is recorded and which is not.

- Press **CHANGE** to select the desired Start method:

The available options depend on the selection of Recording Source § 4. Start Method options are discussed in § 4.1.1 , § 4.2.1 and § 4.3.

- Press **NEXT** to move on to the next menu item.

12.3 Telephone settings

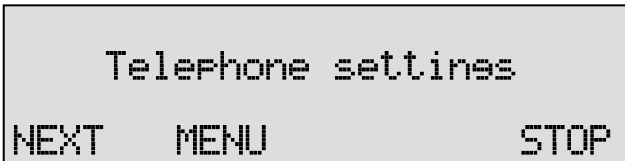

- Press **MENU** to enter the Telephone settings menu.

The first item in the Telephone Settings is the Telephone mode.



- Press **CHANGE** to enable or disable the telephone function (See also § 7) of the Single II.

If you select Telephone mode: Off

- Press **BACK** to move on to the next menu. (go to § 12.4)

If you select Telephone mode: On

- Press **NEXT** to go to the next menu item

12.3.1 External handset



- Press **CHANGE** to toggle On and Off
- Press **NEXT** to go to the next menu item.

12.3.2 Flash time

```
Hook-Flash time:      110mS
NEXT      - CHANGE +   BACK
```

- Press **CHANGE** to alter the Hook-Flash time.

Flash time refers to the switch time of the Hook flash. Standard setting for the Hook-Flash is 110 mSeconds. Check with your PBX or service provider for information.

- Press **NEXT** to move on to the next menu item.

12.3.3 Wait after dial

The Wait after dial is the time the Single II waits to start recording after the first number is dialled. Default the **Wait after dial** is set to 4.0 seconds. A shorter time may cause the Single II to record the dialling of the number. A longer wait after dial may cause the Single II not to record the beginning of the conversation.

```
Wait after dial:      4.0s
NEXT      - CHANGE +   BACK
```

- Press + or – to increase or decrease the value.
- Press **NEXT** to move on to the next menu item.

12.3.4 Caller ID

To change this setting you should be aware of the caller ID that is used in your country or region. Please contact your reseller for this information.

```
Caller ID:           DTMF-Pola
NEXT                CHANGE  BACK
```

- Press **CHANGE** to set the type of Caller ID.

The choices are:

- DTMF-pola,
- DTMF-ring,
- FSK-pola.
- FSK-ring
- DTMF Hi imp

You can also turn the Caller ID Off.

- Press **NEXT** to move on to the next menu item.

12.3.5 K-break detection

This menu item will only appear when the Single II language is set to English. K-break detection is specific for the UK.



- Press **CHANGE** to enable or disable K-break detection.

This service needs to be supported by your PABX or your telephone service provider.

- Press **NEXT** to move on to the next menu item.

12.3.6 Rings to answer on

Sets the amount of rings before the Single II answers the phone.

This option is only used when you want the call recorder to act as an answering machine.

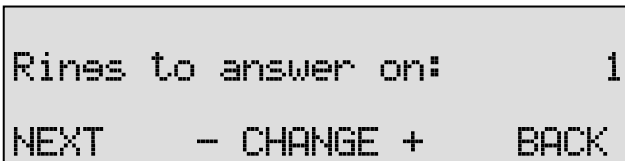

- Press **- or +** to change the Ring volume property.
- Press **NEXT** to move on to the next menu item.

12.3.7 Rings always answer

Set the amount of rings before the Single II answers the phone when the answering machine is off. After picking up the phone the answering

machine is automatically turned on. If you don't want the Single II to answer the phone when the answering machine is off select **Off**.

```
Rings Always Answer:    Off
NEXT      - CHANGE +    BACK
```

- Press – or + to alter the number of rings to always answer on.
- Press **NEXT** to move on to the next menu item.

12.3.8 Ring Volume

The Ring volume determines the volume of the ringer. Select a value between 0 and 12.

```
Ring volume:           3
NEXT      - CHANGE +    BACK
```

- Press – or + to change the Ring volume property.
- Press **NEXT** to move on to the next menu item.

12.3.9 Ring frequency

Ring frequency determines the pitch of the ring, the higher the numbers, the higher the sound.

Select a value between 400+50 and 3400+350.

```
Ring frequency:       1200+250
NEXT      - CHANGE +    BACK
```

- Press – or + to change the Ring frequency property.
- Press **NEXT** to move on to the next menu item.

12.3.10 Ring variation

Ring variation determines the variation in the sound of the ring, the user will have to try different variations to find out which suits him best. Select a value between 1x3 and 3x12.

```
Ring variation:      2x5
NEXT      - CHANGE +      BACK
```

- Press **CHANGE** to change the Ring variation property.
- Press **NEXT** to move on to the next menu item.

12.3.11 Speaker after answer

This function puts the conversation on speaker automatically after a call is answered.

```
Speaker after Answer: Off
NEXT                  CHANGE  BACK
```

- Press **CHANGE** enable or disable Speaker after answer.
- Press **BACK** to move on to the next menu.

12.3.12 Maximum message time

The **Maximum message time** determines the maximum duration of a message. Default the Max. message time is set to 120 seconds.

```
Max. message time:  1200s
NEXT      - CHANGE +      BACK
```

- Press - or + to set the **Maximum message time** in steps of 30s .
Maximum message time is the last menu item in the Telephone Settings.
- Press **BACK** to exit the Telephone settings menu.
- Press **NEXT** to move on to the Recorder settings.

12.4 Recorder Settings



- Press **MENU** to enter the Recorder Settings menu.

12.4.1 CryptoCard

The CryptoCard function is used to encrypt recordings. Encryption is described in Chapter 10.

The CryptoCard is the first item in the Recorder Settings.



- Press **CHANGE** to enable or disable the CryptoCard function.

Only in case a CryptoCard is inserted the personal code of the card can be set or changed.

Insert your CryptoCard and press **NEXT** to set the personal code of your card.



- Press **CHANGE** to change Card code.

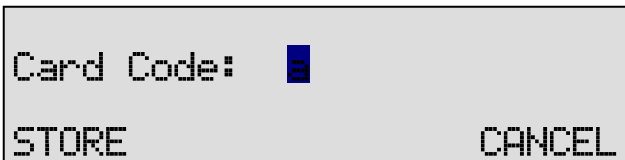

- First enter the original code of the card and press **CONTINUE**.

```
New Card Code: █
STORE                               CANCEL
```

- Enter a numerical code and press **STORE**.

```
Repeat Card Code: █
STORE                               CANCEL
```

- Repeat the code and press **STORE** again to store the code.

```
Crypto Card:                        On
NEXT                                CHANGE  BACK
```

- Press **NEXT** to move on to the next menu item.

12.4.2 Automatic SD Copy

The **Automatic SD copy** is described in § 6.

```
Auto copy to SD Card: Off
NEXT                                CHANGE  BACK
```

- Press **CHANGE** to enable or disable Automatic SD copy.
- Press **NEXT** to move on to the next menu item.

12.4.3 Notification

The **Notification** is described in § 3.2.

The Notification options are:

- Off
- Tone
- Message
- Tone + Message

```
Notification:           Off
NEXT                   CHANGE  BACK
```

- Press **CHANGE** to select the required Notification method.

To record the notification message follow instructions in § 8.2. Then follow these instructions, they replace the 'how to record a Welcome message information.

- Press **SYSTEM** en select message number 340
- Press the **Record** Key to start recording the Notification message
- Press **STOP** to stop recording
- Press **PLAY** to play the message back
- Press **STORE** to save the message

- Press **NEXT** to move on to the next menu item.

12.4.4 Ask Store/Delete

Every call is recorded when Automatic recording is on, but not every recording has to be stored. If the **Ask Store/Delete** function is enabled the user can decide, after the recording has ended whether to keep the recording or not. The Single II will prompt the user after every recording. The decision period is 60 seconds. After that the recording will automatically be stored.

```
Ask Store/Delete:     Off
NEXT                   CHANGE  BACK
```

- Press **CHANGE** to enable **Ask Store/Delete** .
- Press **NEXT** to move on to the next menu item.

12.4.5 Beep after store

The **Beep after store** function sounds a beep after a recording is stored.

```

Beep after store:      Off
NEXT                   CHANGE  BACK

```

- Press **CHANGE** to enable **Beep after store** .
- Press **NEXT** to move on to the next menu item.

12.4.6 Minimum call time

The **Minimum call time** is the minimum duration of a recording to be stored. Default the Minimum call time is set to 5 seconds. Recordings shorter than 5 seconds will not be stored.

```

Minimum call time:    4s
NEXT   - CHANGE +   BACK

```

- Press + or – to increase or decrease the value.
- Press **NEXT** to move on to the next menu item.

12.4.7 Signal settings

The Signal settings appear in the settings menu only when Voice activated recording has been selected, see § 12.2.

```

Signal Settings
NEXT                   CHANGE  STOP

```

- Press **CHANGE** to open the signal settings.

```

A1...X...S.....
          <<  >>  BACK

```

The Start level is indicated with the **S** sign.
The Stop level is indicated with the **X** sign.



The Start level can be moved with the << and >> **menu** keys.
The Stop level can be moved with the << and >> **recorder** keys.

The "S" indicates the start level for recording, the "X" indicates the stop level to stop recording.

Pick up the connected telephone and the signal of the dial tone will be displayed as a black bar:



For the Call Recorder to start recording the displayed audio level needs to exceed the "S" sign as is the case in the example above. Adjust the start level by pressing the soft-keys below the << and >> in the display. It is advised to set the start level approximately three units below the actual audio level of the dial tone.

To stop the recording the audio level needs to fall below the cross sign ("x"). Adjust the stop level with the  and  recorder keys. It is advised to keep the stop level approximately three units above the actual audio level the Call Recorder is supposed to stop on. For the Call Recorder to actually stop recording the audio level needs to fall below the set stop level for a certain amount of time. This amount of time is called the Silence Period.

- Press **Back** when the Start and Stop levels have been set.

When set the next menu item will be "Silence Period", which is used to detect a remote hang-up in case there is no normal disconnect tone

The Silence period setting is located in the Recorder Settings menu. See § 12.4.9

Start with a relatively short Silence timeout of 5 seconds and begin varying the Start and Stop level. Begin with a relatively low Start level where the dial tone will start a recording and where speaking in the handset will keep the recording to continue longer than the 5 seconds of the Silence timeout.

Then start raising the Stop level until you find a setting where not speaking into the handset actually stops the recording after the 5 seconds of the silence timeout.

Once a correct setting for the Start and Stop level has been found the Silence timeout can be raised. A comfortable setting would be a time of 20 - 30 seconds. This will lift the recording over most silences in telephone calls and will hardly join two consecutive calls into a single recording.

12.4.8 Start Period

The Start period setting will only appear when Voice activated recording is enabled. The Start period is described in § 4.2.2.

```
Start Period:           100ms
NEXT      - CHANGE +   BACK
```

- Press + or – to increase or decrease the value.
- Press **NEXT** to move on to the next menu item.

12.4.9 Silence period

The Silence period setting will only appear when Voice activated recording is enabled. The Silence period is described in § 4.2.2.

```
Silence Period:       10s
NEXT      - CHANGE +   BACK
```

- Press + or – to increase or decrease the value.
- Press **NEXT** to move on to the next menu item.

12.4.10 Compression

The effect **Compression** has on the amount of disk space used per recording is described in § 3.3

```
Compression:           Off
NEXT                   CHANGE  BACK
```

- Press **CHANGE** to select On or Off.
- Press **NEXT** to move on to the next menu item.

12.4.11 Microphone mode

The **Microphone mode** options are:

- Internal
- External

```
Microphone mode:  Internal
NEXT              CHANGE  BACK
```

- Press **CHANGE** to select the desired **Microphone mode**.
- Press **NEXT** to move on to the next menu item.

12.4.12 Microphone amplification

The **Microphone amplification** determines the amplification of the microphone signal, where 1 is the lowest and 4 is the highest:

```
Mic. amplification:  4
NEXT              CHANGE  BACK
```

- Press **CHANGE** to adjust the **Microphone amplification**.
- Press **NEXT** to move on to the next menu item.

12.4.13 Automatic Gain Control

The **Automatic Gain control** function is described in § 3.5.

```
Auto. Gain control:  On
NEXT              CHANGE  BACK
```

- Press **CHANGE** to enable **Automatic Gain control**.
- Press **NEXT** to move on to the next menu item.

12.4.14 Footswitch

The **Footswitch** function allows you to use a footswitch for playback of recordings.

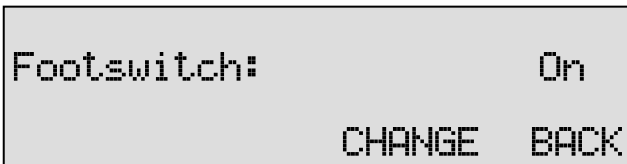

- Press **CHANGE** to enable **Footswitch** use.

Footswitch is the last menu item in the Recorder Settings.

- Press **BACK** to exit
- Press **STOP** to exit the Recorder settings menu.

You will be prompted to **SAVE** or **CANCEL** changes made.

- Press **NEXT** to move on to the Network settings.

12.5 Network settings

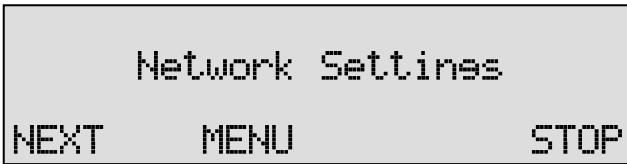

- Press **MENU** to enter the Network Settings menu.

12.5.1 Network active

The first item in the Network Settings is the Network active item.

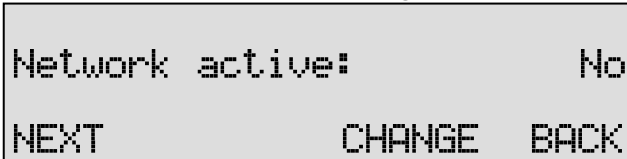

- Press **CHANGE** to enable the network, it is only then that the option **NEXT** appears in the display.
- Press **NEXT** to move on to the next menu item.

12.5.2 FTP active

FTP stands for File Transfer Protocol. This is the protocol used by the Single II to communicate over the network. This is a protocol that is also used for internet.

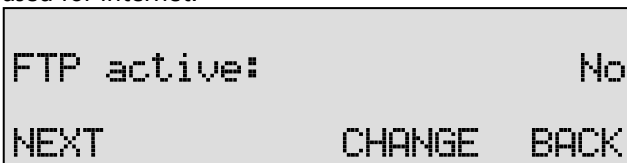

- Press **CHANGE** to enable FTP.
- Press **NEXT** to move on to the next menu item.

12.5.3 FTP user

The Ftp user is user name of the Single II. It is used by the Archive software to log on to the Single II.

```
FTP user: 0000
NEXT          CHANGE  BACK
```

- Press **CHANGE** to change the Ftp user name.

```
FTP user: █
STORE          CLEAR  CANCEL
```

Use the numerical keys to enter the Ftp user name. Use the  to switch between upper case and lower case characters. Press the numerical keys once for a, twice for b etc.

- Press **STORE** to save the Ftp user name.
- Press **NEXT** to move on to the next menu item.

12.5.4 FTP password

The Ftp password of the Single II is the password that goes with the FTP user name of the Single II. It is used by the Archive software to log on to the Single II.

```
FTP Pwd: 0000
NEXT          CHANGE  BACK
```

- Press **CHANGE** to change the Ftp password.

```
FTP Pwd: █
STORE          CLEAR  CANCEL
```

Use the numerical keys to enter the Ftp user name. Use the  to switch between upper case and lower case characters. Press the numerical keys once for a, twice for b etc.

- Press **STORE** to save the Ftp password.

- Press **NEXT** to move on to the next menu item.

12.5.5 FTP server port

Ftp server port is the port number through which the Archive software can log on to the Single II. The Ftp server port is default set to 21, as is the setting of the port number in the Archive software. If there is no direct reason to change the Ftp server port it is best left unchanged.

```
FTP server port: 21
NEXT             CHANGE  BACK
```

- Press **CHANGE** to change the Ftp server port number.

```
FTP server port: █
STORE           CLEAR  CANCEL
```

Use the numerical keys to enter the Ftp server port number.

- Press **STORE** to save the Ftp server port number.
- Press **NEXT** to move on to the next menu item.

12.5.6 DHCP server

If a DHCP (Dynamic Host Configuration Protocol) server is used on the network the DHCP server functionality can be enabled, if not the DHCP server must be disabled. A router as used in a small office often behaves like a DHCP server.

```
Use DHCP server:      No
NEXT             CHANGE  BACK
```

- Press **CHANGE** to enable DHCP server.
- Press **NEXT** to move on to the next menu item.

12.5.7 IP address

As part of the network the Single II needs an IP address. When a DHCP server is used (see previous item) the DHCP server will assign an IP address to the Single II.

If "Use DHCP server" is set to "NO" a static IP address must be given to the Single II.

```
IP addr: 0.0.0.0
NEXT          CHANGE  BACK
```

- Press **CHANGE** to enter the IP address of the Single II.

```
IP addr: 000.000.000.000
STORE          CANCEL
```

Use the numerical keys to enter the IP address of the Single II.

- Press **STORE** to save the IP address of the Single II.
- Press **NEXT** to move on to the next menu item.

12.5.8 IP subnet mask

The IP subnet mask is used by the Single II if access from outside the network is required. In this case the Gateway will need to be entered as well. In case the used SMTP server is not on the local network the IP mask and gateway need to be entered.

```
IP mask: 255.255.255.000
NEXT          CHANGE  BACK
```

Press **CHANGE** to change the IP subnet mask of the Single II.

```
IP mask: 55.255.255.000
STORE          CANCEL
```

Use the numerical keys to enter the IP subnet mask of the Single II.

- Press **STORE** to save the IP subnet mask of the Single II.
- Press **NEXT** to move on to the next menu item.

12.5.9 Gateway

The Single II uses the Gateway if access from outside the network is required. If so both the Gateway and the IP subnet mask must be entered. For instance, if the used SMTP server (e-mail server) is not on the local network the IP mask and gateway are required.

```

Gateway: 0.0.0.0
NEXT             CHANGE   BACK
  
```

- Press **CHANGE** to enter the Gateway of the Single II.

```

Gateway: 00.000.000.000
STORE             CANCEL
  
```

Use the numerical keys to enter the Gateway of the Single II.

- Press **STORE** to save the Gateway of the Single II.
- Press **NEXT** to move on to the next menu item.

12.5.10 IP name

Aside from the IP address the Single II can also be addressed by an IP name if this function is supported by your DNS server.

```

IP name: AM3-00041
NEXT             CHANGE   BACK
  
```

- Press **CHANGE** to enter an IP name for the Single II.

```

IP name: 
STORE             CANCEL
  
```

Use the numerical keys to enter the Ftp user name. Use the  to switch between upper case and lower case characters. Press the numerical keys once for a, twice for b etc.

- Press **STORE** to save an IP name for the Single II.
- Press **NEXT** to move on to the next menu item.

12.5.11 NTP server

If an NTP (Network Time Protocol) server is used on the network the NTP server functionality can be enabled. The Call Recorder can acquire the correct time from the Network Time Server.

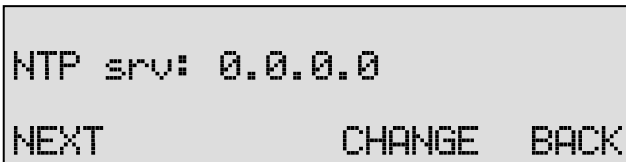

NTP srv: 0.0.0.0
NEXT CHANGE BACK

- Press **CHANGE** to enter the NTP server address.

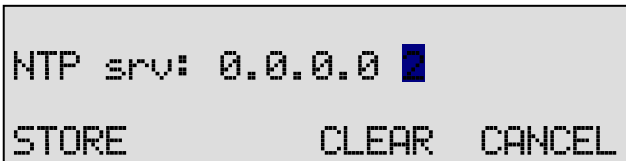

NTP srv: 0.0.0.0 
STORE CLEAR CANCEL

Use the numerical keys to enter the NTP server address.

- Press **STORE** to save the NTP server address.
- Press **NEXT** to move on to the next menu item.

12.5.12 NTP port

NTP server port is the port number through which the Call Recorder connects to the NTP server. The NTP server port is set to 123 by default. If there is no direct reason to change the NTP server port it is best left unchanged.



NTP server port: 123
NEXT CHANGE BACK

- Press **CHANGE** to change the NTP server port number.

```
NTP server Port: █  
STORE          CLEAR  CANCEL
```

Use the numerical keys to enter the NTP server port number.

- Press **STORE** to save the NTP server port number.
- Press **NEXT** to move on to the next menu item.

12.5.13 GMT correction

GMT (Greenwich mean Time) correction property is used to identify the time zone. NTP servers normally issues GMT. GMT correction can be set in half hours from -15:00 to + 15:00. East of Greenwich (London, England) will be +, west will be -.

```
GMT correction:      00:00  
NEXT    - CHANGE +    BACK
```

- Press + or - to increase or decrease the GMT correction.
- Press **NEXT** to move on to the next menu item.

12.5.14 Monitor Active

The Monitor function sends the voice data of ongoing calls over the network to a PC that has registered the recorder within the RTR Call Monitor software.

```
Monitor active:      No  
NEXT          CHANGE  BACK
```

- Press **CHANGE** to enable the Monitor function for the Single II.

```
Monitor Pwd: █  
          CHANGE  BACK
```

Use the numerical keys to enter the Ftp user name. Use the **>>>** to switch between upper case and lower case characters. Press the numerical keys once for a, twice for b etc.

Monitor is the last menu item in the Network Settings.

- Press **BACK** to exit
- Press **STOP** to exit the Network settings menu.

You will be prompted to SAVE or CANCEL changes made.

12.6 Clock

```
Clock:  Mon 01-08-14 11:54
NEXT          CHANGE  STOP
```

- Press **CHANGE** to set the clock

```
Clock:  Mon 01-08-14 11:54
STORE  <<  >>  CANCEL
```

- Press keys **1 - 7** to change the day beginning with 1 for Sunday
- Enter the date (format depending on selected language) using the numerical keys
- Enter the **time**
- Press **STORE** to save the time.

Other options:

CANCEL to return to previous set time.

<< and **>>** to move the cursor.

- Press **NEXT** to move on to the next menu item.

12.7 Password

Password protection is provided as a minimum level of prevention against unauthorized setting changes. When Password protection is enabled all Settings and Playback functions are disabled.



Password: Off
NEXT CHANGE STOP

- Press **CHANGE** to enable Password protection.



New Password: █

Enter a numerical password.

- Press **STORE**



Repeat Password: █
STORE CANCEL

Repeat the password.

- Press **STORE** again to store the password.



Password: On
NEXT CHANGE STOP

For every time the Password protection is enabled a new password has to be entered. This is to prevent the password protection to be enabled without the password being known.

- Press **NEXT** to move on to the next menu item.

12.8 Language

```
Language:      English
NEXT          CHANGE  STOP
```

- Press **CHANGE** to scroll through the available options.

Together with the Language the date format can change also:

Standard date format is: DD-MM-YY

When set to "American" the format is changed to : MM-DD-YY

When set to American the format is changed to: MM-DD-YY

12.9 Reset all Values

The Reset all values prompt is used to revert the Single II to factory settings.

Warning: Reverting to factory settings may cause personal settings to be lost.

```
Reset all values:      No
NEXT                  CHANGE  STOP
```

- Press **CHANGE** to enable Reset all values operation.

Reset all Values is the last item in the settings.

- Press **BACK** to exit
- Press **STOP** to exit the Network settings menu.

You will be prompted to SAVE or CANCEL changes made

Acknowledgements

12.10 Guarantee

Your Single II has a 12-month factory guarantee. The guarantee is effective for normal use only. We would like to emphasize that the guarantee is not valid under exceptional environmental conditions, such as extreme temperatures or humidity levels, nor in the unlikely event of a lightning strike. The guarantee is not valid if the machine has not been handled properly, for example when it has been dropped, or bumped into. In order to qualify for guarantee, you should contact your supplier, and show the receipt. If your supplier cannot help you, you should contact the manufacturer. The manufacturer reserves the right to determine the final date of the guarantee period on the basis of the date of production. Costs of transport to and from the supplier or the manufacturer are for the buyer's account. Guarantee is for parts only and does not cover any costs resulting from the breakdown of the Single II.

The Single II has various extra features that have not been described in this manual. Additional information about this is given in a technical information bulletin. Subjects discussed in this technical documentation are further configuration options and remote configuring. The further configuration options concern all aspects of operation. In our experience most people are interested in configurations related to user's access.

12.11 Liability

Correct functioning of the Single II cannot be guaranteed under all conditions and thus we do not accept any liability for loss of information or other damages due to the use of the Single II.

Vidicode is not a source of official interpretation of laws of any country or state and shall not be construed as a source for making decisions.

13 Index

A

Accept a call, 35
Acknowledgements, 74
Add a contact, 42
Analog telephone, 23
Answering machine, 36
Ask Store/Delete, 58
Audio signal, 26
Automatic Gain Control, 22
Automatic recording, 21

B

Beep after store, 58

C

Caller ID, 52
Clock, 16
Connections, 15
Copy recordings, 31
CryptoCard, 45

D

DHCP server, 65, 68
Digital telephone, 25

E

Edit a contact, 43
Encrypted recording, 46
End a call, 35

F

Flash time, 52
Footswitch, 62
Function keys, 13

G

Guarantee, 74

H

Hang-up detection, 53
Headset, 33

I

IP address, 66
IP name, 68

L

Language, 17
Liability, 74

M

Maximum message time, 55
Menu keys, 13
Menu-key indicators, 13
Messages, 38
Microphone mode, 22
Minimum call time, 59

N

Network
 Ftp active, 63
 gateway, 67
Notification, 21

P

PIN and PUC code, 45
Playback, 38
Power adapter, 16

R

Record source, 23
Recording calls, 19
Recording quality, 22
Remove a contact, 44

S

Search, 28
 according to code, 30
Search a contact, 42
Server port, 65, 69
Settings, 49
Signal settings, 59
Silence timeout, 27
Speakerphone, 33
Start a call, 34
start level, 60
Start-level, 26
stop level, 60
Stop-level, 26

Subnet mask, 66

T

Telephone book, 42
Telnet protocol, 48

U

USB to Ethernet, 48
User interface, 13
User name, 64

V

Volume, 14

W

Welcome message, 37
 Record, 37
Wildcard, 32